

RSBPT325

[400 WATT MAX.]

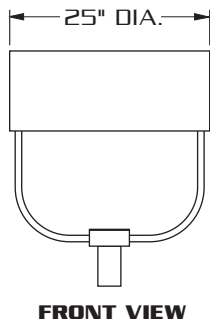

E.P.A. = 1.51

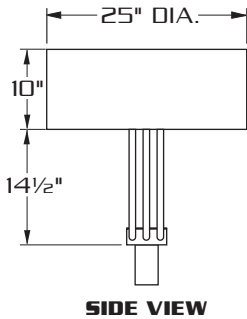

SPECIFICATIONS

- HOUSING:** HEAVY WALL SPUN ALUMINUM CONSTRUCTION. ENTIRE HOUSING SURFACE SHALL BE FREE OF WELDS OR SEAMS.
- LENS ASS'Y:** ONE PIECE HINGED HEAVY GAUGE DIE FORMED ALUMINUM DOOR FRAME SURROUNDS 3/16" CLEAR TEMPERED GLASS LENS. GLASS IS SEALED TO DOOR WITH HIGH TEMPERATURE SILICONE SEAL. CAPTIVE THUMB SCREW DISENGAGES LENS ASSEMBLY AND ACTIVATES ACCUHINGE™ HINGE TO ALLOW LENS ASSEMBLY TO HINGE AWAY FROM HOUSING FOR LUMINAIRE ACCESS WITHOUT THE USE OF TOOLS.
- OPTICS:** COMPUTER DESIGNED ONE PIECE SEMI SPECULAR HYDROFORMED REFLECTOR. COMBINES WITH CLEAR TEMPERED GLASS LENS TO PRODUCE A HIGHLY EFFICIENT, SHARP CUTOFF.
- GASKETING:** CLOSED CELL EPDM GASKETING COMPRESSED BETWEEN DOOR AND HOUSING WORKS IN COMBINATION WITH ACCUHINGE™ HINGE TO PRESSURE SEAL OPTICAL CHAMBER.
- LAMP HOLDER:** MOGUL BASE PORCELAIN.
- LAMP:** (BY OTHERS)
- BALLAST:** H.P.F./C.W.A. AUTOTRANSFORMER. -20° STARTING TEMPERATURE.
- ARM:** SIX (6) EXTRUDED ALUMINUM (.84 O.D.) ARMS WELDED TO A CAST ALUMINUM POLE TOP FITTER. ARMS ARE INTERNALLY WELDED TO LENS FRAME.
- FINISH:** POLYESTER POWDER COAT-STATE OF THE ART 20 PSI PRESSURE POWER WASH AT 140° TEMPERATURE INCORPORATES FOUR STEP IRON PHOSPHATE PROCESS TO CLEANSE AND PRETREAT THE METAL SURFACE FOR MAXIMUM PAINT ADHESION. ELECTROSTATICALLY APPLIED TEXTURED POLYESTER POWDER TOP COAT IS BAKED AT 400° TEMPERATURE FOR MAXIMUM HARDNESS AND EXTERIOR DURABILITY.



660 WEST AVENUE O, PALMDALE, CA. 93551
(661) 233-2000
FAX NO. (661) 233-2001
www.usaltg.com

A7-7
REV. 10 / 03

MOUNTING STYLES

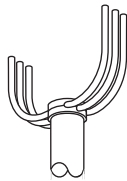

PTA

STANDARD TENON ASSEMBLY FOR 4" & 5" DIA. POLES.

DECORATIVE RING SUPPLIED FOR 6" DIA. POLES. (SPECIFY POLE I.O.)

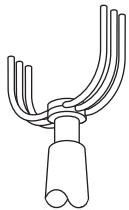

PTB

TENON ASSEMBLY FOR TAPERED OR SQUARE POLES. TENON ASSEMBLY IS ALSO AVAILABLE AS AN OPTION FOR 4", 5" OR 6" DIA. POLES

SPECIFY MOUNTING ASSEMBLY:

PTB27-TO FIT OVER 2 7/8" O.D. TENON.

PTB23-TO FIT OVER 2 3/8" O.D. TENON.

WALL MOUNT

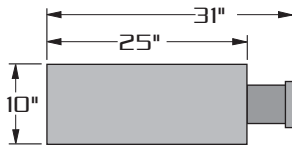
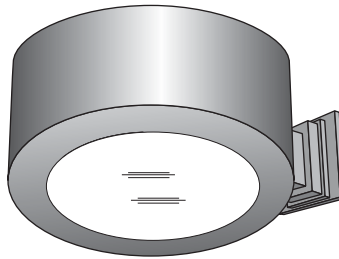

EXTRUDED ALUMINUM ARM AND CAST ALUMINUM WALL BRACKET ASSEMBLY PROVIDED WITH BUILT IN GASKETED WIRE ACCESS FOR FIXTURE/SUPPLY WIRE CONNECTION.

WALL PLATE

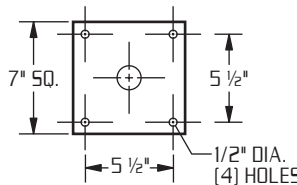

**LAMP SIZE:
250 - 400 WATT**

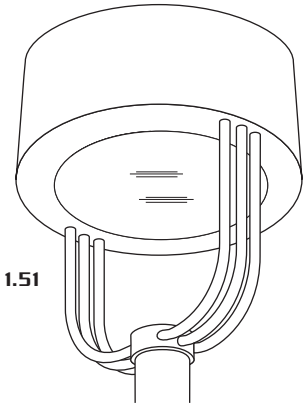

E.P.A. = 1.51

HEAVY GAUGE SPUN ALUMINUM HOUSING.

FIVE LIGHT DISTRIBUTIONS AVAILABLE.

OPTICAL SYSTEMS ENCLOSED IN IMPACT RESISTANT TEMPERED GLASS LENS.

TOOLESS ENTRY TO LAMP COMPARTMENT.

ORDERING INFORMATION

| MODEL NO. : | OPTICS | WATTAGE TYPE VOLTAGE | MOUNTING | FINISH | OPTIONS |
|--|---|--|--|--|---|
| RSBPT325 | | | | | |
| MODEL NO. : | OPTICS | LAMP | MOUNTING | FINISH | OPTIONS |
| R S B P T 3 2 5 | <input type="checkbox"/> TYPE II II..... (hydroform) | <input type="checkbox"/> 400 <input type="checkbox"/> HPS <input type="checkbox"/> 120 | <input type="checkbox"/> PTA | <input type="checkbox"/> DARK BRONZE DBM | <input type="checkbox"/> CLEAR POLYCARBONATE DIFFUSERLEX |
| | <input type="checkbox"/> TYPE III III..... (hydroform) | <input type="checkbox"/> 250 <input type="checkbox"/> MH <input type="checkbox"/> 208 | | <input type="checkbox"/> MEDIUM BRONZE MBM | <input type="checkbox"/> HOUSE SIDE SHIELDHS |
| | <input type="checkbox"/> TYPE IV (FORWARD THROW) IV..... (segmented) | <input type="checkbox"/> MV <input type="checkbox"/> 240 | | <input type="checkbox"/> BLACK BKM | <input type="checkbox"/> PHOTO CELL + VOLTAGE (EXAMPLE: PC120V)PC+V |
| | <input type="checkbox"/> TYPE V (SEGMENTED) V-SQ... (segmented) | <input type="checkbox"/> 277 | | <input type="checkbox"/> WHITE WTM | <input type="checkbox"/> TWIST LOCK PHOTO CELL+VOLTAGE (EXAMPLE TPC120V)TPC+V |
| | | <input type="checkbox"/> 480 | | <input type="checkbox"/> SILVER SLM | <input type="checkbox"/> TWIST LOCK RECEPTACLE ONLYTPR |
| | <input type="checkbox"/> MT | | <input type="checkbox"/> PTB23 (TO FIT 2 3/8" O.D.) | <input type="checkbox"/> OPTION: <input type="checkbox"/> ANODIZED AZ ANODIZED HOUSING MUST HAVE PAINT FINISH COAT EXAMPLE: AZDBM | <input type="checkbox"/> SINGLE FUSE (120V., 277V)SF |
| | | | <input type="checkbox"/> PTB27 (TO FIT 2 7/8" O.D.) | SEE PAGE 3 FOR ADDITIONAL COLORS | <input type="checkbox"/> DOUBLE FUSE (208V., 240V)DF |
| | | METAL HALIDE UNITS ONLY USE ED28 LAMP FOR 400 W. | WALL MOUNT <input type="checkbox"/> WM | | |