

(1000 WATT MAX.)

RVL29

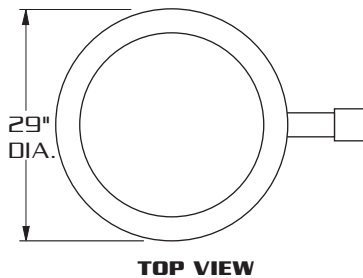

E.P.A. = 2.37

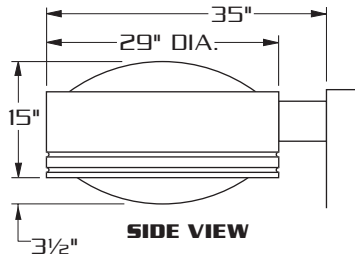

WM



1



2-180



2-90



3-90



3-120



4-90

SPECIFICATIONS

HOUSING: HEAVY WALL SPUN ALUMINUM CONSTRUCTION WITH INTEGRAL DOMED TOP. TWIN FLUTES HAVE BEEN INTEGRATED WITH HOUSING TO ADD AESTHETIC VALUE AND TO PROVIDE FOR MULTI COLORED BANDS TO SIGNATURIZE INSTALLATION.

LENS ASS'Y: ONE PIECE HINGED HEAVY GAUGE DIE FORMED ALUMINUM DOOR FRAME SURROUNDS 3/16" CLEAR CONVEX GLASS LENS. GLASS IS SEALED TO DOOR WITH HIGH TEMPERATURE SILICONE SEAL. CAPTIVE THUMB SCREW DISENGAGES LENS ASSEMBLY AND ACTIVATES ACCUHINGE™ HINGE TO ALLOW LENS ASSEMBLY TO HINGE AWAY FROM HOUSING FOR LUMINAIRE ACCESS WITHOUT THE USE OF TOOLS.

OPTICS: COMPUTER DESIGNED ONE PIECE SEGMENTED SPECULAR REFLECTOR COMBINES WITH CLEAR CONVEX LENS TO PRODUCE A HIGHLY EFFICIENT WIDE SYMMETRIC LIGHT DISTRIBUTION WITH OUTSTANDING UNIFORMITY.

GASKETING: CLOSED CELL EPDM GASKETING COMPRESSED BETWEEN DOOR AND HOUSING WORKS IN COMBINATION WITH ACCUHINGE™ HINGE TO PRESSURE SEAL OPTICAL CHAMBER.

LAMP HOLDER: MOGUL BASE PORCELAIN.

LAMP: (BY OTHERS)

BALLAST: H.P.F./C.W.A. AUTOTRANSFORMER. -20° STARTING TEMPERATURE.

ARM: 3"X5"X6" LONG HEAVY WALL EXTRUDED ALUMINUM. ARM IS SECURED TO HOUSING AND TO POLE WITH THREE (3) STAINLESS STEEL RODS.

FINISH: POLYESTER POWDER COAT-STATE OF THE ART 20 PSI PRESSURE POWER WASH AT 140° TEMPERATURE INCORPORATES FOUR STEP IRON PHOSPHATE PROCESS TO CLEANSE AND PRETREAT THE METAL SURFACE FOR MAXIMUM PAINT ADHESION. ELECTROSTATICALLY APPLIED TEXTURED POLYESTER POWDER TOP COAT IS BAKED AT 400° TEMPERATURE FOR MAXIMUM HARDNESS AND EXTERIOR DURABILITY.



660 WEST AVENUE O, PALMDALE, CA. 93551
(661) 233-2000
FAX NO. (661) 233-2001
www.usaltg.com

A8-3
REV. 10 / 03

TYPICAL SQUARE POLE TEMPLATE

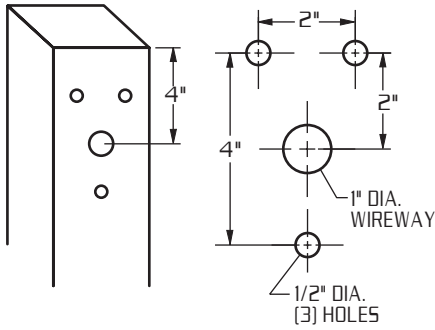

TYPICAL ROUND POLE TEMPLATE

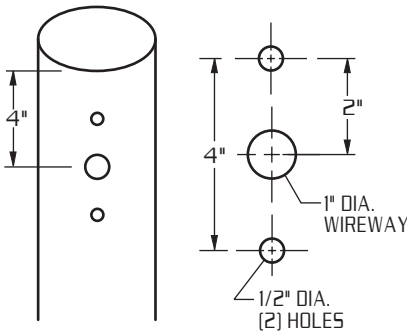

WALL MOUNT

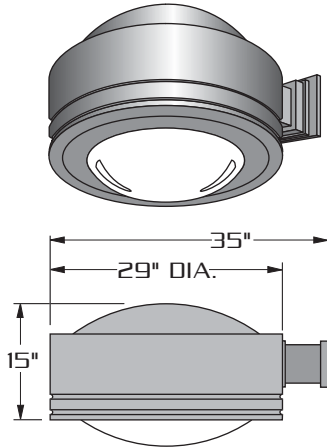

EXTRUDED ALUMINUM ARM AND CAST ALUMINUM WALL BRACKET ASSEMBLY PROVIDED WITH BUILT IN GASKETED WIRE ACCESS FOR FIXTURE/SUPPLY WIRE CONNECTION.

WALL PLATE

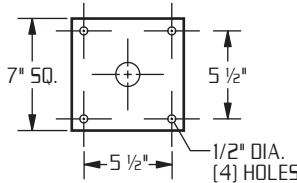

**LAMP SIZE:
1000 WATT**

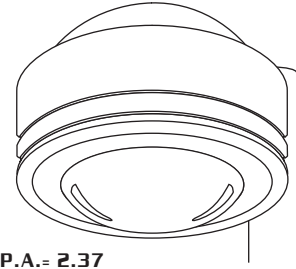

E.P.A.= 2.37

- WIDE THROW BEAM PATTERN.**
- VERTICAL LAMP.**
- COMPUTER DESIGNED SEGMENTED OPTICS.**
- THREE OPTICAL CONFIGURATIONS.**
- FLAT GLASS OPTION FOR FULL CUTOFF OPTICS.**

ORDERING INFORMATION

MODEL NO. : RVL29	OPTICS	WATTAGE TYPE VOLTAGE	MOUNTING	FINISH	OPTIONS
R V L 2 9	<input type="checkbox"/> ASYMMETRIC ASY...	<input type="checkbox"/> 1000 MH (BT56,BT37) <input type="checkbox"/> 120	<input type="checkbox"/> 1	<input type="checkbox"/> DARK BRONZE DBM	<input type="checkbox"/> FLAT TEMPERED GLASS..... FG
	<input type="checkbox"/> TYPE IV (FORWARD THROW) IV..... (HORIZONTAL LAMP)	<input type="checkbox"/> 1000 PSMH (BT37) <input type="checkbox"/> 208	<input type="checkbox"/> ST 23 (TO FIT OVER 2 3/8" O.D. ARM)	<input type="checkbox"/> MEDIUM BRONZE MBM	<input type="checkbox"/> CLEAR POLYCARBONATE DIFFUSER LEX
	<input type="checkbox"/> TYPE V V-SQ...	<input type="checkbox"/> 750 PSMH (BT37) <input type="checkbox"/> 240	<input type="checkbox"/> WM	<input type="checkbox"/> BLACK BKM	<input type="checkbox"/> HOUSE SIDE SHIELD HS
		<input type="checkbox"/> 480		<input type="checkbox"/> WHITE WTM	<input type="checkbox"/> PHOTO CELL + VOLTAGE (EXAMPLE: PC120V) PC+V
		<input type="checkbox"/> MT		<input type="checkbox"/> SILVER SLM	<input type="checkbox"/> TWIST LOCK PHOTO CELL+VOLTAGE (EXAMPLE TPC120V) TPC+V
		<input type="checkbox"/> 1000 HPS (E25)		OPTION: <input type="checkbox"/> ANODIZED AZ ANODIZED HOUSING MUST HAVE PAINT FINISH COAT EXAMPLE: AZDBM	<input type="checkbox"/> TWIST LOCK RECEPTACLE ONLY..... TPR
		<input type="checkbox"/> 750 HPS (BT37)		SEE PAGE 3 FOR ADDITIONAL COLORS	<input type="checkbox"/> SINGLE FUSE (120V., 277V) SF
		1000 MH WITH FG OPTION USE (BT37)			<input type="checkbox"/> DOUBLE FUSE (208V., 240V) DF
		1000 HPS NOT AVAILABLE WITH FG OPTION			



660 WEST AVENUE O, PALMDALE, CA. 93551
 (661) 233-2000
 FAX NO. (661) 233-2001
 www.usaltg.com