

LUMENATOR-C

[400 WATT MAX.]

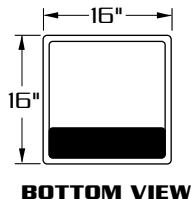
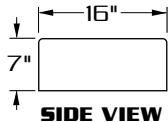

SPECIFICATIONS

HOUSING: PRECISE. CORROSION RESISTANT RADIUSED CAST ALUMINUM CONSTRUCTION.

LENS ASS'Y: PRECISE. CORROSION RESISTANT CAST ALUMINUM DOOR FRAME SURROUNDS 3/16" CLEAR TEMPERED GLASS LENS. GLASS IS SEALED TO DOOR WITH HIGH TEMPERATURE SILICONE SEAL.

OPTICS: COMPUTER DESIGNED SPECULAR SEGMENTED REFLECTOR WITH AN AUXILIARY HAMMERED PATTERNED TOP REFLECTOR COMBINES WITH CLEAR TEMPERED LENS TO PRODUCE AN EFFICIENT SHARP CUTOFF LIGHT DISTRIBUTION.

GASKETING: CLOSED CELL EPDM GASKETING COMPRESSED BETWEEN DOOR AND HOUSING SEALS OPTICAL CHAMBER.

LAMP HOLDER: MOGUL BASE PORCELAIN.

LAMP: (BY OTHERS)

BALLAST: H.P.F./C.W.A. AUTOTRANSFORMER, -20° STARTING TEMPERATURE.

FINISH: POLYESTER POWDER COAT-STATE OF THE ART 20 PSI PRESSURE POWER WASH AT 140° TEMPERATURE INCORPORATES FOUR STEP IRON PHOSPHATE PROCESS TO CLEANSE AND PRETREAT THE METAL SURFACE FOR MAXIMUM PAINT ADHESION. ELECTROSTATICALLY APPLIED TEXTURED POLYESTER POWDER TOP COAT IS BAKED AT 400° TEMPERATURE FOR MAXIMUM HARDNESS AND EXTERIOR DURABILITY.



660 WEST AVENUE O, PALMDALE, CA. 93551
(661) 233-2000
FAX NO. (661) 233-2001
www.usaltg.com

**TRUNNION MOUNT
(TM)**

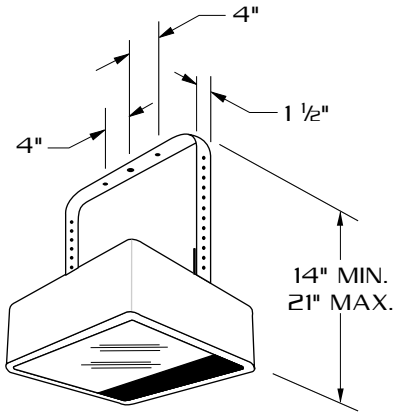

TRUNNION BRACKET FABRICATED FROM 3/16" X 1 1/2" ALUMINUM. [4] 1/4"-20 BOLTS PROVIDED TO ADJUST TRUNNION. TRUNNION BRACKET PROVIDED WITH [1] 9/16" DIA. CENTER HOLE AND [2] 7/16" DIA. HOLES.

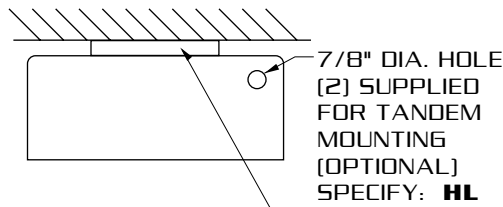

1" X 8" X 10" CAST ALUMINUM CANOPY (CNP) REQUIRED FOR COMBUSTIBLE CEILING

BACK SIDE

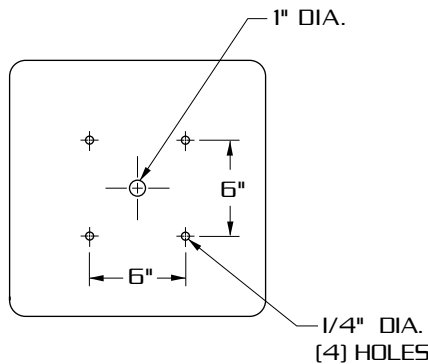

**LAMP SIZE:
100 - 400 WATT**

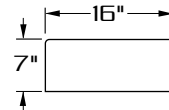
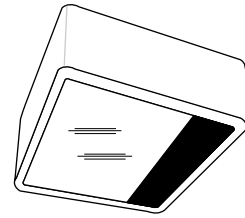

PRECISE COMPUTER DESIGNED, SEGMENTED SHARP CUTOFF OPTICS.

IMPACT RESISTANT TEMPERED GLASS LENS.

RADIUSED CORNER HOUSING DESIGN.

ORDERING INFORMATION

MODEL NO. : LUM-C	OPTICS	WATTAGE TYPE VOLTAGE	FINISH	OPTIONS
LUM-C	<p>HORIZONTAL LAMP REFLECTORS</p> <p><input type="checkbox"/> TYPE III HR-III..... (segmented, horizontal lamp)</p> <p><input type="checkbox"/> TYPE IV (FORWARD THROW) HR-IV..... (segmented, horizontal lamp)</p> <p><input type="checkbox"/> TYPE V HR-V-SQ..... (segmented, horizontal lamp)</p> <p>VERTICAL LAMP REFLECTORS</p> <p><input type="checkbox"/> ASYMMETRIC ASY..... (segmented, vertical lamp, 175 w. max)</p> <p><input type="checkbox"/> TYPE V VR-V-SQ..... (segmented, vertical lamp, 175 w. max)</p>	<p>WATTAGE TYPE VOLTAGE</p> <p><input type="checkbox"/> 400 <input type="checkbox"/> HPS <input type="checkbox"/> 120</p> <p><input type="checkbox"/> 250 <input type="checkbox"/> MH <input type="checkbox"/> 208</p> <p><input type="checkbox"/> 200 <input type="checkbox"/> MV <input type="checkbox"/> 240</p> <p><input type="checkbox"/> 175 <input type="checkbox"/> 277</p> <p><input type="checkbox"/> 150 <input type="checkbox"/> 480</p> <p><input type="checkbox"/> 100 <input type="checkbox"/> MT</p> <p>METAL HALIDE UNITS ONLY USE ED28 LAMP FOR 400 W. USE MEDIUM BASE LAMP FOR VERTICAL LAMP REFLECTOR USE MEDIUM BASE LAMP FOR 100 W.</p>	<p><input type="checkbox"/> DARK BRONZE DBM</p> <p><input type="checkbox"/> MEDIUM BRONZE MBM</p> <p><input type="checkbox"/> BLACK BKM</p> <p><input type="checkbox"/> WHITE WTM</p> <p><input type="checkbox"/> SILVER SLM</p>	<p><input type="checkbox"/> CLEAR POLYCARBONATE DIFFUSER LEX</p> <p><input type="checkbox"/> SINGLE FUSED (120V., 277V) SF</p> <p><input type="checkbox"/> DOUBLE FUSE (208V., 240V) DF</p> <p><input type="checkbox"/> QUARTZ RESTRIKE QTZ</p> <p><input type="checkbox"/> 3/8" IPS STEM MOUNT AND SWIVEL CANOPY (4'-0" MAX.) SM</p> <p><input type="checkbox"/> CANOPY CNP</p> <p><input type="checkbox"/> TAMPER PROOF HARDWARE TP</p> <p><input type="checkbox"/> 7/8 DIA. HOLE HL</p> <p><input type="checkbox"/> TRUNNION MOUNT TM</p>
			SEE PAGE 3 FOR ADDITIONAL COLORS	

