

PSLS16

[250 WATT MAX.]

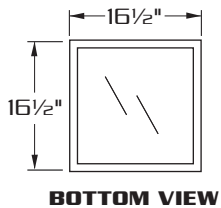
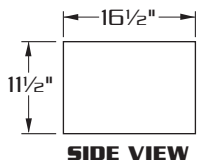

SPECIFICATIONS

- HOUSING:** ONE PIECE, DIE FORMED ALUMINUM CONSTRUCTION. ALUMINUM DOOR FRAME PROVIDED WITH SPRING LOADED HINGE AND A SPRING LOADED FASTENER FOR EASY ACCESS.
- LENS ASS'Y:** PRECISE, DIE FORMED ALUMINUM DOOR FRAME SURROUNDS 3/16" CLEAR TEMPERED GLASS LENS. GLASS IS SEALED TO DOOR WITH HIGH TEMPERATURE SILICONE SEAL.
- OPTICS:** COMPUTER DESIGNED SPECULAR SEGMENTED REFLECTOR WITH AN AUXILIARY HAMMERED PATTERNED TOP REFLECTOR COMBINES WITH 3/16" CLEAR TEMPERED LENS TO PRODUCE AN EFFICIENT SHARP CUTOFF LIGHT DISTRIBUTION.
- GASKETING:** CLOSED CELL EPDM GASKETING COMPRESSED BETWEEN DOOR AND HOUSING SEALS OPTICAL CHAMBER.
- LAMP HOLDER:** MOGUL BASE PORCELAIN.
- LAMP:** [BY OTHERS]
- BALLAST:** H.P.F./C.W.A. AUTOTRANSFORMER. -20° STARTING TEMPERATURE.
- FINISH:** POLYESTER POWDER COAT-STATE OF THE ART 20 PSI PRESSURE POWER WASH AT 140° TEMPERATURE INCORPORATES FOUR STEP IRON PHOSPHATE PROCESS TO CLEANSE AND PRETREAT THE METAL SURFACE FOR MAXIMUM PAINT ADHESION. ELECTROSTATICALLY APPLIED TEXTURED POLYESTER POWDER TOP COAT IS BAKED AT 400° TEMPERATURE FOR MAXIMUM HARDNESS AND EXTERIOR DURABILITY.



660 WEST AVENUE O, PALMDALE, CA. 93551
(661) 233-2000
FAX NO. (661) 233-2001
www.usaltg.com

A1-5
REV. 10 / 03

**TRUNNION MOUNT
(TM)**

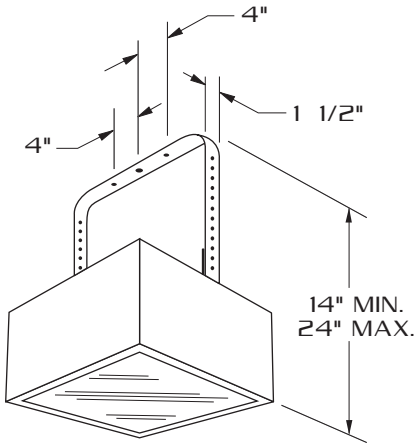

TRUNNION BRACKET FABRICATED FROM 3/16" X 1 1/2" ALUMINUM. (4) 1/4"-20 BOLTS PROVIDED TO ADJUST TRUNNION. TRUNNION BRACKET PROVIDED WITH (1) 9/16" DIA. CENTER HOLE AND (2) 7/16" DIA. HOLES.

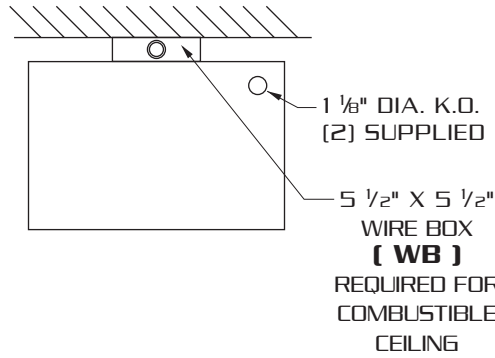

1 1/2" DIA. K.O. (2) SUPPLIED
5 1/2" X 5 1/2"
**WIRE BOX
(WB)**
REQUIRED FOR COMBUSTIBLE CEILING

BACK SIDE

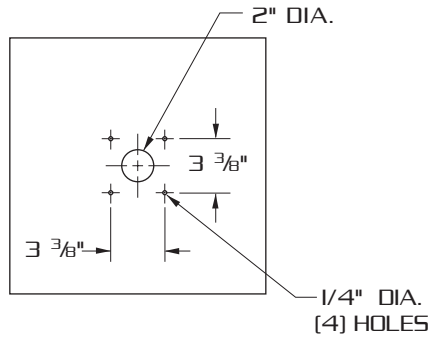



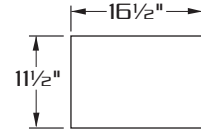
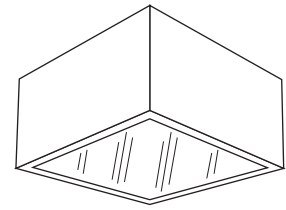

**LAMP SIZE:
100 - 250 WATT**



**PRECISE COMPUTER DESIGNED,
SEGMENTED SHARP CUTOFF
OPTICS.**

**IMPACT RESISTANT TEMPERED
GLASS LENS.**

ORDERING INFORMATION

MODEL NO. : PSLS16	OPTICS	WATTAGE TYPE VOLTAGE	FINISH	OPTIONS
P S L S 1 6	HORIZONTAL LAMP REFLECTORS	WATTAGE TYPE VOLTAGE	<input type="checkbox"/> DARK BRONZE DBM <input type="checkbox"/> MEDIUM BRONZE MBM <input type="checkbox"/> BLACK BKM <input type="checkbox"/> WHITE WTM <input type="checkbox"/> SILVER SLM	<input type="checkbox"/> 1 1/2" X 5 1/2" X 5 1/2" WIRE BOX WB <input type="checkbox"/> CLEAR POLYCARBONATE DIFFUSER LEX <input type="checkbox"/> HOUSE SIDE SHIELD HS <input type="checkbox"/> SINGLE FUSED (120V., 277V) SF <input type="checkbox"/> DOUBLE FUSE (208V., 240V) DF <input type="checkbox"/> QUARTZ RESTRIKE QZ <input type="checkbox"/> 3/8" IPS STEM MOUNT AND SWIVEL CANOPY (4'-0" MAX.) SM <input type="checkbox"/> TRUNNION MOUNT TM
	<input type="checkbox"/> TYPE III HR-III  (segmented, horizontal lamp) <input type="checkbox"/> TYPE IV (FORWARD THROW) HR-IV  (segmented, horizontal lamp) <input type="checkbox"/> TYPE V HR-V-SQ  (segmented, horizontal lamp)	<input type="checkbox"/> 250 <input type="checkbox"/> HPS <input type="checkbox"/> 120 <input type="checkbox"/> 200 <input type="checkbox"/> MH <input type="checkbox"/> 208 <input type="checkbox"/> 175 <input type="checkbox"/> MV <input type="checkbox"/> 240 <input type="checkbox"/> 150 <input type="checkbox"/> <input type="checkbox"/> 277 <input type="checkbox"/> 100 <input type="checkbox"/> <input type="checkbox"/> 480 <input type="checkbox"/> <input type="checkbox"/> <input type="checkbox"/> MT		
VERTICAL LAMP REFLECTORS <input type="checkbox"/> ASYMMETRIC ASY  (segmented, vertical lamp, 175 w. max) <input type="checkbox"/> TYPE V VR-V-SQ  (segmented, vertical lamp, 175 w. max)	METAL HALIDE UNITS ONLY USE ED28 LAMP FOR 400 W. USE MEDIUM BASE LAMP FOR VERTICAL LAMP REFLECTOR USE MEDIUM BASE LAMP FOR 100 W.			



660 WEST AVENUE O, PALMDALE, CA. 93551
(661) 233-2000
FAX NO. (661) 233-2001
www.usaltg.com